

SPALDING®

2020 EQUIPMENT CATALOG BASKETBALL | GYMNASIUM | VOLLEYBALL

WWW.SPALDINGEQUIPMENT.COM | 800-435-3865



— TABLE OF CONTENTS —

BASKETBALL

- 04 – 05 | ARENA RENEGADE® PORTABLE BACKSTOP
- 06 – 07 | ARENA® PORTABLE BACKSTOP
- 08 – 09 | BENEFITS OF ARENA BACKSTOPS
- 10 – 11 | PORTABLE ASSESSMENT & CUSTOMIZATION
- 12 – 13 | G8 & G5
- 14 – 15 | 2500 & 2000 BACKSTOP
- 16 – 17 | FASTBREAK 960 & 940, THE BEAST® & FASTBREAK 930
- 18 – 19 | 8' TOURNAMENT PORTABLE
- 20 – 23 | BASKETBALL GOALS
- 24 – 25 | GLASS BACKBOARDS
- 26 | E-Z BOLT™ PACKAGING
- 27 | BACKBOARD PACKAGE
- 28 | HELIX® HEIGHT ADJUSTERS
- 29 | NON-GLASS BACKBOARDS
- 30 – 33 | BASKETBALL ACCESSORIES

GYMNASIUM

- 34 – 37 | CEILING-SUSPENDED BACKSTOPS
- 38 | WALL-BRACED BACKSTOPS
- 39 | BATTING CAGES
- 40 – 41 | DIVIDER CURTAINS
- 42 – 43 | WALL PADDING
- 44 | COMPONENTS
- 45 | COACH'S NOTES & WARRANTY

LEVEL OF PLAY ICONS





OFFICIAL SUPPLIER OF
BACKSTOP, BACKBOARD,
AND GOAL TO:



OFFICIAL MEMBER OF:



MEMBER



BASKETBALL



FIBA
EQUIPMENT
& VENUE



For over 30 years Spalding has been revolutionizing portable backstops, and we are proud to showcase the Arena Renegade® at the NCAA Final Four Tournaments and in all NBA Facilities across the United States and Canada. Its state-of-the-art design allows this premium unit to stand out on-court or on television. When the top competitors play on this system, why wouldn't you want it in your facility?

ARENA RENEGADE®

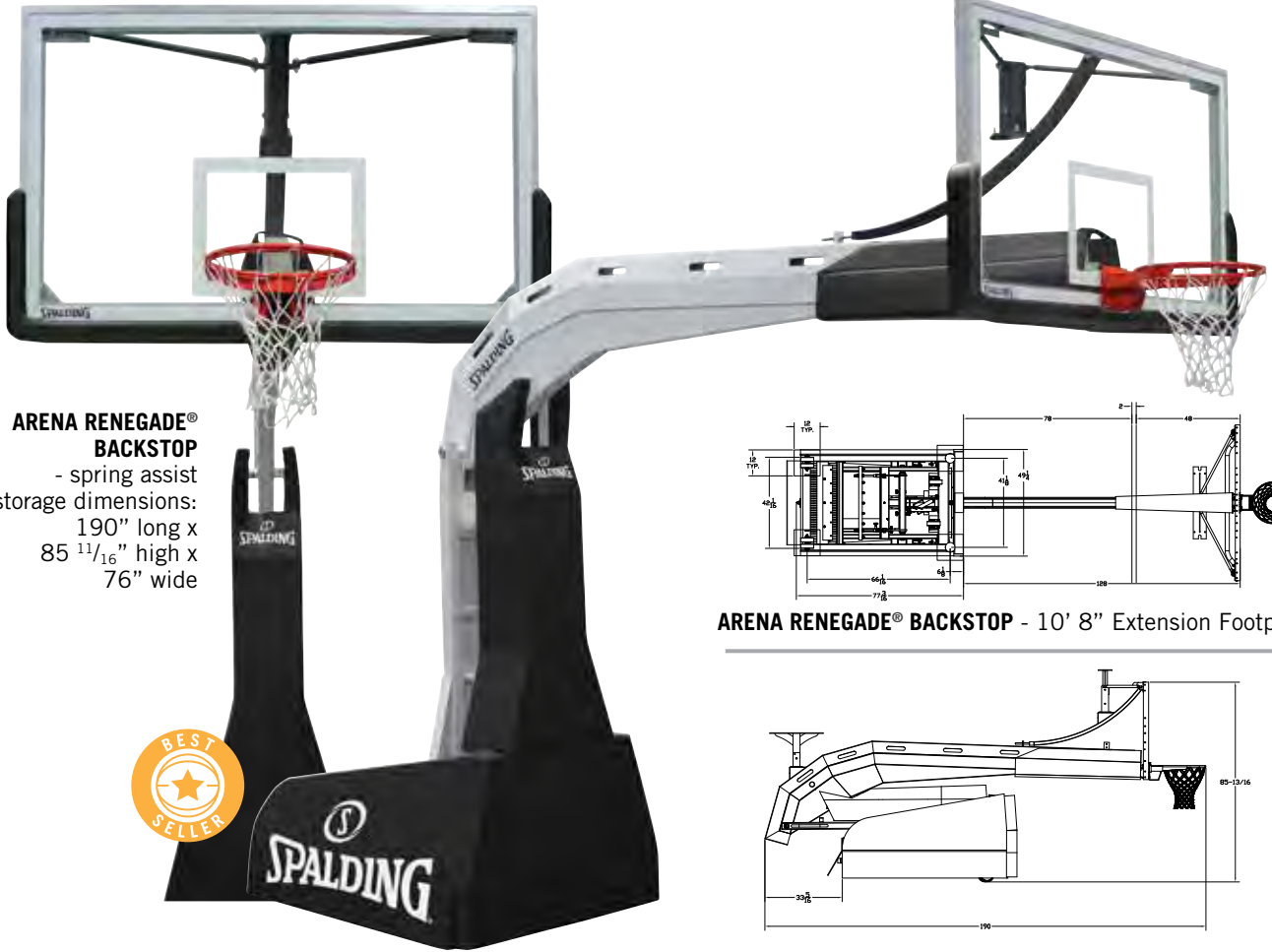

**ARENA RENEGADE®
BACKSTOP**
- spring assist
storage dimensions:
190" long x
85 11/16" high x
76" wide



ARENA RENEGADE® BACKSTOP - 10' 8" Extension Footprint

NEW SLIM PROFILE

Provides greater audience visibility

IMPROVED STRUCTURAL RIGIDITY

by increasing the size of the safety lock and telescopic adjustment tube

HIDDEN CABLE CHANNEL

on the boom helps give a cleaner appearance during play

STABILITY LOCK

helps decrease sway

BACKSTOP FEATURES:

- Available in 10' 8" and 8' extensions to meet all professional, collegiate, high school, and international specifications
- Arena Renegade® SuperGlass™ Prosb™ Backboard (413-100) (42" x 72") with limited lifetime warranty
- Slam-Dunk® Precision 180sb™ Goal with limited 7-year warranty
- Protective padding covered in 30 oz. vinyl
- Counterweight of 1500 to 2000 lbs. for superior stability
- E-Z Bolt™ Backboard padding available in 12 color options (see page 11 for colors)

401-050 Arena Renegade® Backstop–Spring Assist with 10' 8" extension

401-060 Arena Renegade® Backstop–Spring Assist with 8' extension

BENEFITS OF ARENA® SYSTEMS - SEE PAGES 8-9



Spalding® Arena® Backstop has satisfied the highest levels of competition since its inception with the NBA D-League. It may not have all the bells and whistles of the Arena Renegade® but it is the unit that gave the Arena Renegade® its name. If high quality and performance are what you are looking for, look no further than the Spalding® Arena Renegade® Backstop.

ARENA® BACKSTOP

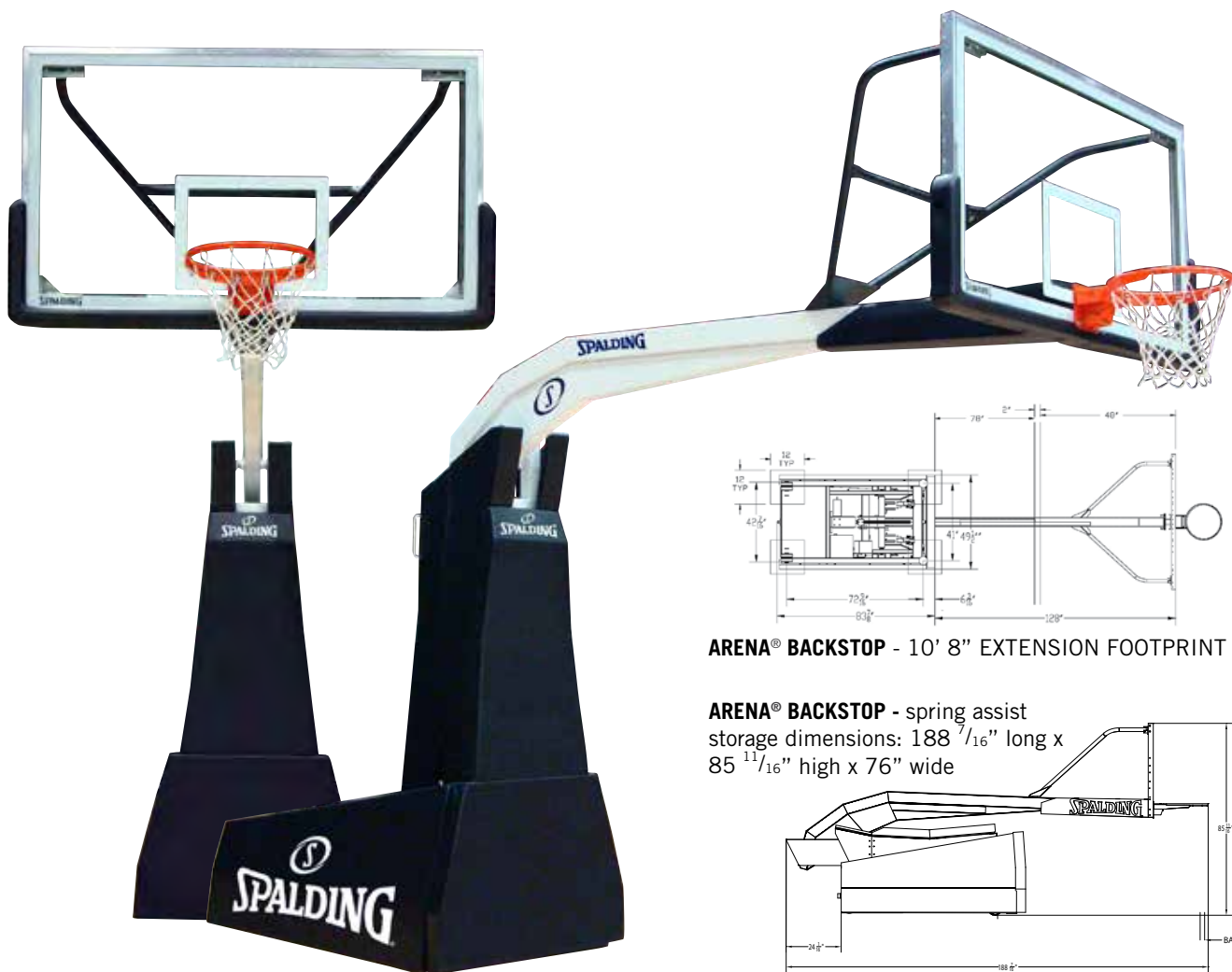

ARENA® BACKSTOP - 10' 8" EXTENSION FOOTPRINT

ARENA® BACKSTOP - spring assist storage dimensions: 188 7/16" long x 85 11/16" high x 76" wide

BACKSTOP FEATURES:

- Available in 10' 8" and 8' extensions to meet all professional, collegiate, high school and international specifications
- Counterweight of 1500 to 2000 lbs. for superior stability
- Rolls on six - 6" x 2" casters for maximum load dispersion
- SuperGlass™ Prosb™ Backboard (413-002) (42" x 72") with limited lifetime warranty
- Slam-Dunk® Precision 180sb™ Goal with limited 7-year warranty
- Protective padding covered in 30 oz. vinyl
- E-Z Bolt™ Backboard padding available in 12 color options (see page 11 for colors)

ARENA® BACKSTOP – SPRING ASSIST

- Spring assisted lifting mechanism
- Positive lock at 8', 9' and 10' playing heights

401-990 Arena® Backstop–Spring Assist with 10' 8" extension

401-980 Arena® Backstop–Spring Assist with 8' extension

401-946 Arena® Backstop–Spring Assist with Jack for 10' 8" extension

401-944 Arena® Backstop–Spring Assist with Jack 8' extension

**PADDING
SLIP
COVERS**



BENEFITS OF ARENA® SYSTEMS - SEE PAGES 8-9

BENEFITS OF ARENA® BACKSTOPS

POWDER-COATED FINISH

Each Spalding® backstop is powder-coated to ensure a durable long-lasting finish. Custom frame colors are available to match your facility's color scheme.



INTERNAL WIRING

Shot clock cables and time out indicator wires can all be neatly hidden with the internal wiring option.



AUTOMATIC LIFTING MECHANISM

The ALM system allows Spalding® backstops to be set-up and operated without the use of tools, hydraulics, or sub-frames.



LIFTING MECHANISM

One person can raise and lower the unit in seconds using the spring assisted lifting mechanism and lift assist handles.



FLOOR ANCHOR SYSTEM

A floor anchor system is provided with your backstop to meet the requirements of governing organizations. Whether it is a portable or permanent floor, the Spalding® brand has the anchoring system to meet your needs.



LOCATING SYSTEM

Spalding® backstops employ the best grade of casters, locator pins, and footpads to aid in the simple process of locating your backstop on your court.

CUSTOM LOGOS

School or sponsor logos can be imprinted on the frame padding of all models of Spalding® backstops. Imprinting logos allows you to generate revenue by offering your backstop padding space to local and national sponsors.

See page 11 for customization options.





SHOT CLOCK HOLDERS

Spalding® brand has the capability to fabricate the perfect shot clock holder for your application. The custom matching holders precisely fit your shot clocks to ensure a solid, vibration-free fit, whether it's a front, side, or top-loading shot clock, and two, three, or four-sided.



LED BACKBOARD LIGHTING

The LED backboard lighting is for 42"x72" Strongback & T-plate backboards, 413-002 & 411-007. The backboard lighting is constructed of an aluminum channel with a vinyl edging to protect the glass. The lights work on 12V DC to 24V DC. Kits come with a connecting wire that will need to be connected to the power by an electrician.

401-020 LED Backboard Lighting with DC Connection (compatible with 413002 and 411007 backboards)

401-027 Transformer for LED Lighting (sold separately)



DIRECT MOUNT SYSTEM

The hardware buffer system allows the rim to be mounted directly to the backstop frame without the rim bolts touching the glass. This buffer system eliminates the chance of breaking a backboard during play.

ARENA® ACCESSORIES

PORTABLE ADJUSTMENT BAR

The powder-coated bar is 60" long made of 1 $\frac{1}{8}$ " heavy wall DOM material. The bar has an attached non-marking rubber foot and a soft rubber grip.



401-155 Portable Adjustment Bar

RIM HEIGHT INDICATOR

- No ladder required
- Indicator is 10' in total length



313-450 Rim Height Indicator



PORTABLE ASSESSMENTS

OF ANY BRAND



INSPECTION • RECOMMENDATION • SERVICE

- Our factory representative will visit your facility
- A written report will be provided once inspection is complete
- Additional services available (NCAA rebound elasticity, etc.)
- Volume discounts available, please inquire when booking consultation

**CALL 1.800.435.DUNK (3865) EXT. #6994
TO SCHEDULE AN ASSESSMENT**



**ARENA RENEGADE® | ARENA® BACKSTOP | G8 | G5 BACKSTOPS
REQUIRE PROFESSIONAL/CERTIFIED INSTALLATION.**

Spalding will help facilitate a connection with one of our trained and certified installers.

BACKSTOP CUSTOMIZATION

1. CHOOSE YOUR POWDER-COATED FINISH

STANDARD POWDER-COAT FINISH OPTIONS

Additional colors available for an up charge.



WHITE VEIN



BLACK VEIN



BLUE VEIN



NAVY VEIN



CLASSIC BLUE VEIN



LIME GREEN VEIN



CHROME



MAVERICK BLUE



RED



PINK



ORANGE



GREY



2. CHOOSE YOUR PADDING COLORS



SPALDING OFFERS 80+ PADDING COLORS TO MATCH SCHOOL COLORS

In addition to being easy to clean, Naugahyde fabrics have been proven to be stain-resistant, durable, fire retardant and antimicrobial.

AVAILABLE FOR

- ARENA RENEGADE
- ARENA BACKSTOP
- G8™
- G5™

3. SUBMIT YOUR GRAPHICS



CUSTOM LOGOS

Add a school or sponsor logo to the front or side of your portable backstop padding for additional charge.

* Vector files preferred when submitting artwork.



ALL CUSTOM COLOR PRODUCT SALES ARE FINAL | COLORS SHOWN IN CATALOG AND ON WEBSITE MAY NOT BE AN EXACT MATCH.

G SERIES™ BACKSTOPS



G8™ Backstop
401-975

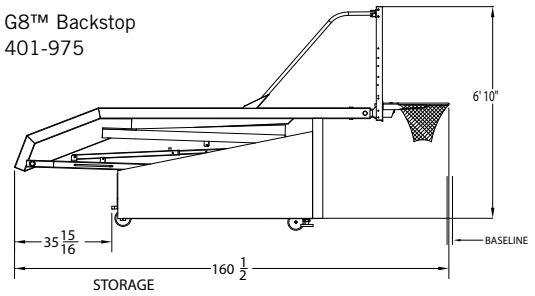

G8™ PORTABLE BACKSTOP

storage dimensions: 160 1/2" long x 6' 10" high x 76" wide

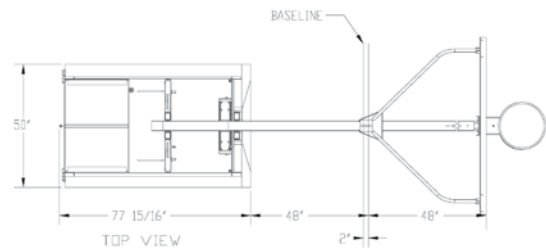

G8™ PORTABLE - 8' Extension Footprint

G8™ BACKSTOP FEATURES:

- Main court backstop for high school and intramural competition
- 8' distance from backboard to front pad at standard height. Height adjustable: 6' - 10'
- 1,000 lbs. of ballast

401-975 G8 Portable Backstop



SHARED FEATURES:

3" THICK PADDING
COVERED IN 30 OZ.
VINYL

SYSTEMS INCLUDE:
SUPERGLASS™ COLLEGIATESB™
BACKBOARD (42" X 72"); E-Z
BOLT™ AND BASE PADDING; FLOOR
ANCHOR

WHITE POWDER-
COATED FINISH
(CUSTOM COLORS
AVAILABLE)



G5™ Backstop
401-970

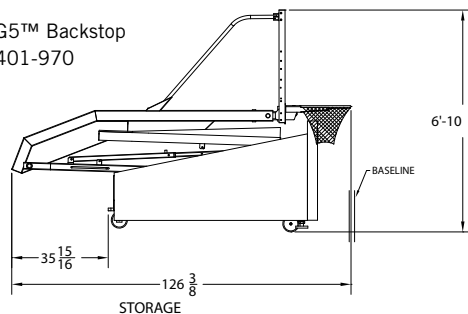

G5™ PORTABLE BACKSTOP
storage dimensions: 126 3/8" long x 6' 10"
high x 76" wide

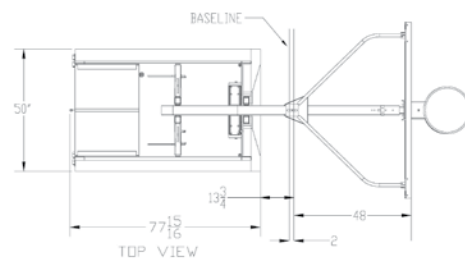

G5™ PORTABLE - 5' Extension Footprint

G5™ BACKSTOP FEATURES:

- Side court backstop for college and professional practice
- 5' distance from backboard to front pad at standard height. Height adjustable: 6' - 10'
- 960 lbs. of ballast

401-970 G5™ Portable Backstop



WARRANTY: BACKSTOP AND LIFTING MECHANISM, 10-YEAR; SUPERGLASS™ COLLEGIATESB™ BACKBOARD, LIFETIME ON DIRECT MOUNTS; SLAM-DUNK® PRECISION 180SB™ GOAL, 7-YEAR; BACKBOARD PADDING, 5-YEAR

SPRING ASSISTED LIFTING MECHANISM (NO TOOLS NEEDED)

ROLLS ON EIGHT - 6" X 2" URETHANE WHEELS FOR MAXIMUM LOAD DISPERSION

2500 PORTABLE BACKSTOP



SPALDING® 2500 PORTABLE
storage dimensions: 115" long x 78" high x 72" wide

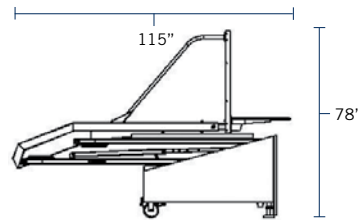
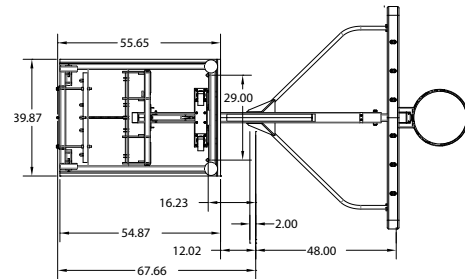

2500 BACKSTOP FEATURES:

- Portable backstop designed with a smaller base to hold a full-size glass backboard for use at colleges, schools, and churches
- 72" x 42" high performance, aluminum framed glass backboard (413-012)
- Goal height is adjustable from 8' to 10'
- Backstop contains 1,000 lbs. of ballast
- White powder-coat finish
- Indoor anchor kit
- Warranty: Backstop frame, 10-year; Telescoping brace, 2-year; Floor pedestals, 2-year; Backboard, 20-year or lifetime on direct mounts; Slammer™ Competitor Goal, 2-year; Backboard Padding, 5-year

401-879 2500 Portable Backstop

SHARED FEATURES:

BACKBOARD IS MADE OF ½" TEMPERED GLASS

SLAMMER™ COMPETITOR GOAL (411-528)

SPRING ASSISTED ONE LEVER HEIGHT ADJUSTMENT (NO TOOLS NEEDED)

2000 PORTABLE BACKSTOP

SPALDING® 2000 PORTABLE
storage dimensions: 119" long
x 77 ½" high x 54" wide

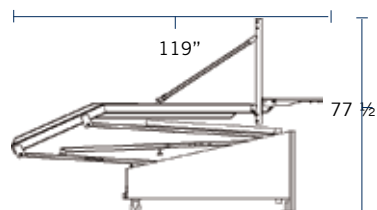
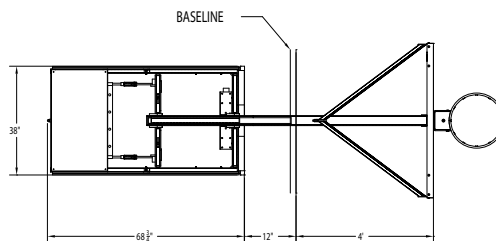

2000 BACKSTOP FEATURES:

- Versatile glass backboard portable basketball system for colleges, schools and churches
- 54" x 42" high performance, aluminum framed glass backboard (411-798)
- 54" Grey Backboard Padding Included
- Goal height is adjustable from 7' 6" to 10'
- Backstop contains 725 lbs. of ballast
- Warranty: Backstop frame, 10-year; Telescoping brace, 2-year; Floor pedestals, 2-year; Backboard, 10-year; Slammer™ Competitor Goal, 2-year

411-800 2000 Portable Backstop

**EXTENSION ARM
PROVIDES 5' OF OFFSET
AT 10' GOAL HEIGHT**

**WILL FIT THROUGH
STANDARD 6' 8"
DOUBLE DOOR WITH
BACKBOARD LOWERED**

**MULTI-PIECE BASE
PADDING INCLUDED
(BLACK ONLY)**

**ROLLS ON FOUR -
4" WHEELS RATED
FOR 600 LBS. EACH**

PORTABLE BACKSTOPS



**FASTBREAK 960™
PORTABLE BACKSTOP**

Storage dimensions: 117"
long x 52" high x 60" wide



**FASTBREAK 940™
PORTABLE BACKSTOP**

Storage dimensions: 117"
long x 52" high x 54" wide



**ADDITIONAL BALLAST WEIGHT
REQUIRED: 300 - 350 lbs.**
recommended (not included)

FASTBREAK 960™ BACKSTOP:

- Designed for institutional use at high schools, camps, churches or health clubs
- 60" x 36" high performance, aluminum framed acrylic backboard
- Easily folded by two people

411-870 Fastbreak 960™ Portable Backstop

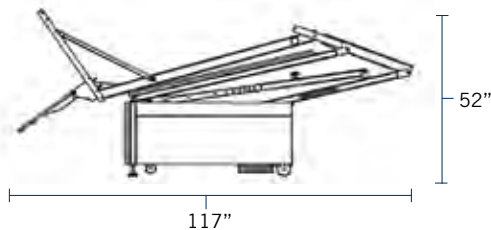

FASTBREAK 940™ BACKSTOP:

- Designed for elementary schools, recreation centers, or as a superior home unit
- 54" x 32" high performance, aluminum framed acrylic backboard
- Backboard folds down for storage

411-860 Fastbreak 940™ Portable Backstop

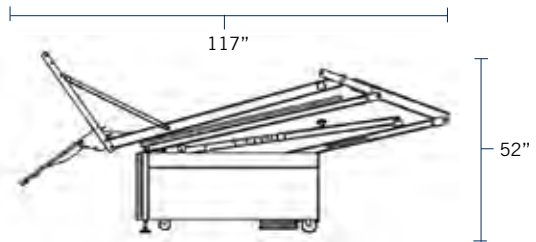

SHARED FEATURES:

- BACKBOARD IS 3/8" THICK ACRYLIC FOR SUPERIOR REBOUND
- EXTENSION ARM PROVIDES 6' OF OFFSET AT 10' GOAL HEIGHT
- PRO IMAGE™ BREAKAWAY GOAL (411-511)
- GOAL HEIGHT IS ADJUSTABLE FROM 7' TO 10'
- MULTI-PIECE BASE PADDING INCLUDED (BLACK)
- BASE DIMENSIONS: 50" X 30" X 21 1/2"
- 2-YEAR LIMITED WARRANTY



**BEAST® GLASS
PORTABLE**



**FASTBREAK 930™
ACRYLIC BACKBOARD**
Storage dimensions: 117"
long x 49" high x 48" wide



ADDITIONAL BALLAST REQUIRED:
300 - 350 lbs. recommended
(not included)

THE BEAST® 60 GLASS PORTABLE:

- Designed for side court recreational or outdoor residential play
- Board size: 60" x 36"
- Tempered glass board
- Steel board frame
- Steel Pro Image™ breakaway rim
- 7.5' to 10' height adjustment; screw jack lift
- 5" square steel pole
- Power Move™ Base fills with 55 gallons of water or sand
- Four wheels
- 5-Year Limited Warranty

421-232 The Beast® 60 Glass Portable

THE BEAST®

FASTBREAK 930™ BACKSTOP:

- Designed for side court recreational play
- Tips back for easy movement on built-in wheels
- Quick set up and take down
- Arena Slam® Breakaway Goal
- Acrylic Backboard is 48" x 32"
- Telescoping poles adjust height from 7' to 10'
- All steel, welded construction
- Base has vinyl trim to avoid marring floors
- Includes full front padding (black)
- Base dimensions: 35 ¼" x 19 ¾" x 13 ¼"
- 2-Year Limited Warranty

411-835 Fastbreak 930™ Portable Backstop w/Acrylic Backboard

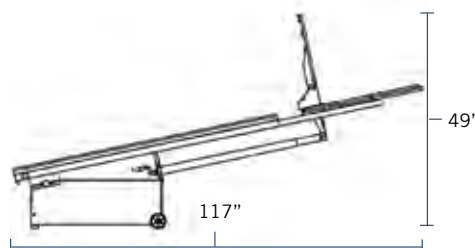

8' PORTABLE BACKSTOP

8' TOURNAMENT PORTABLE BACKSTOP



- Easily sets up in under 45 minutes using minimal staff
- New look, enhanced performance, and setup configurations are designed for indoor tournaments
- Fork pockets allow for easy movement on and off trucks as well as setting the backstop into place
- Backstop contains ALM technology to easily raise the unit with a drill and socket onto four quick leveling corner foot pads at play height
- Quick attach mounting plate allows simple backboard installation
- Telescoping boom easily adjusts for 6', 7' & 8' of run out room while maintaining 10' height
- Easy attach padding wraps the entire base of the unit for safety and creates excellent sponsorship rental space
- 72" x 42" acrylic backboard
- Slam-Dunk® Pro Goal (411-704)
- Powder coated in Spalding® navy vein with navy blue pads – custom color options available

- 401-074 8' Tournament Portable Base
- 401-077 8' Tournament Portable Weight Cart
- 401-034 Backboard Rack (holds 12)

Compact design allows for transportation and storage to and from the court with the folding boom



Backboard braces and rim are conveniently stored in the base during transport

Stackable weight carts provide additional space when transporting

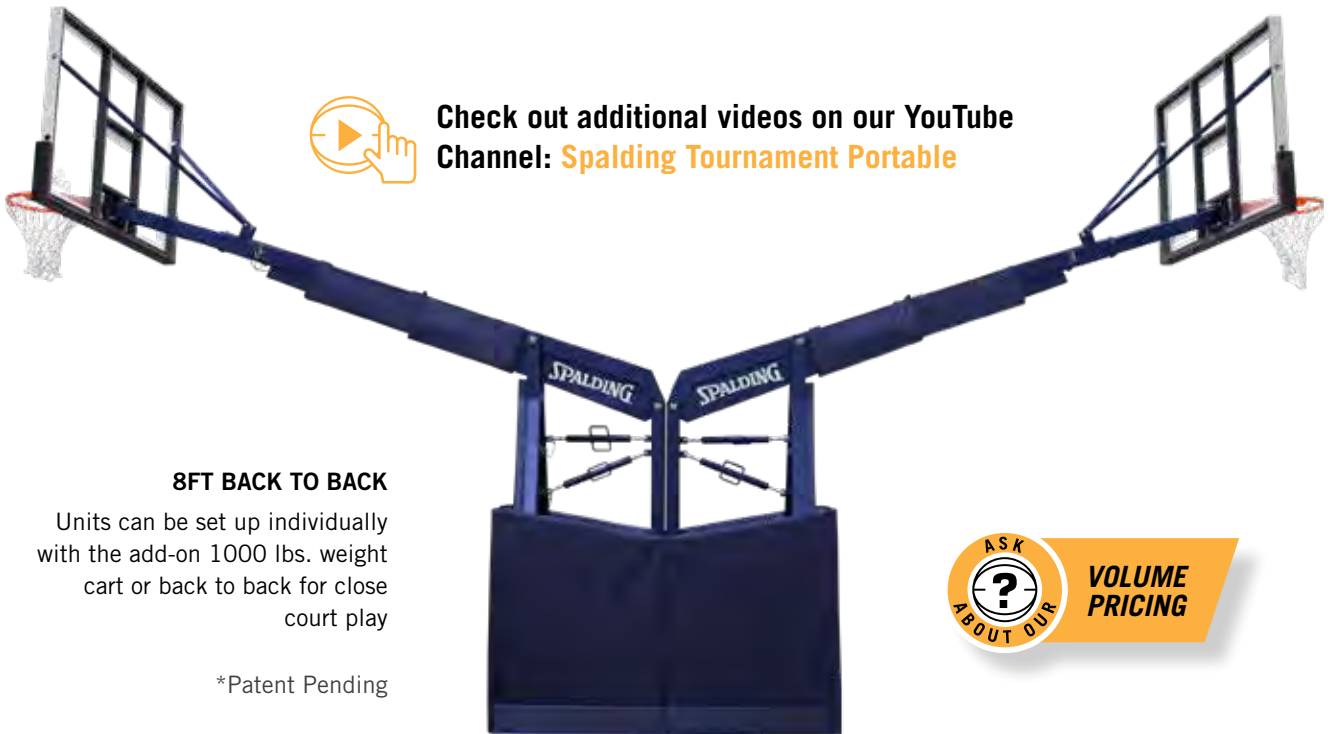

Check out additional videos on our YouTube Channel: [Spalding Tournament Portable](#)

8FT BACK TO BACK

Units can be set up individually with the add-on 1000 lbs. weight cart or back to back for close court play

*Patent Pending



TRUCK DIAGRAMS

BACK TO BACK CONFIGURATION:

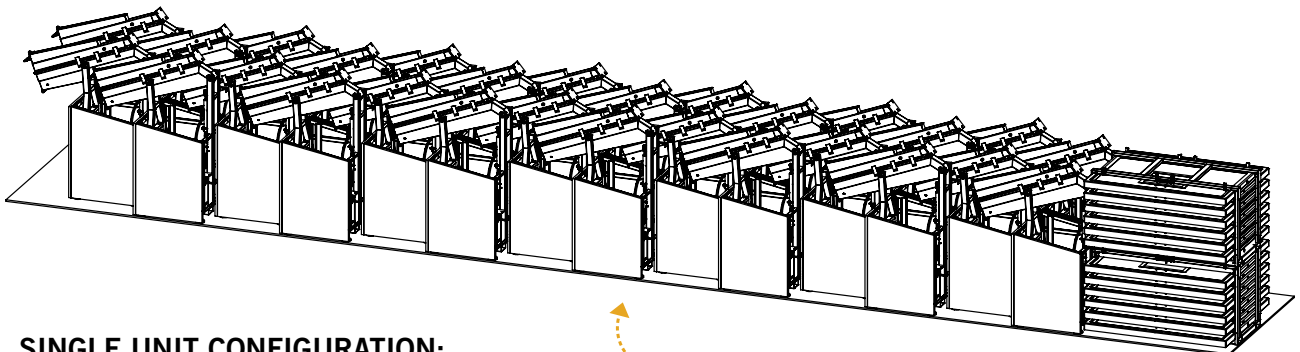

SINGLE UNIT CONFIGURATION:

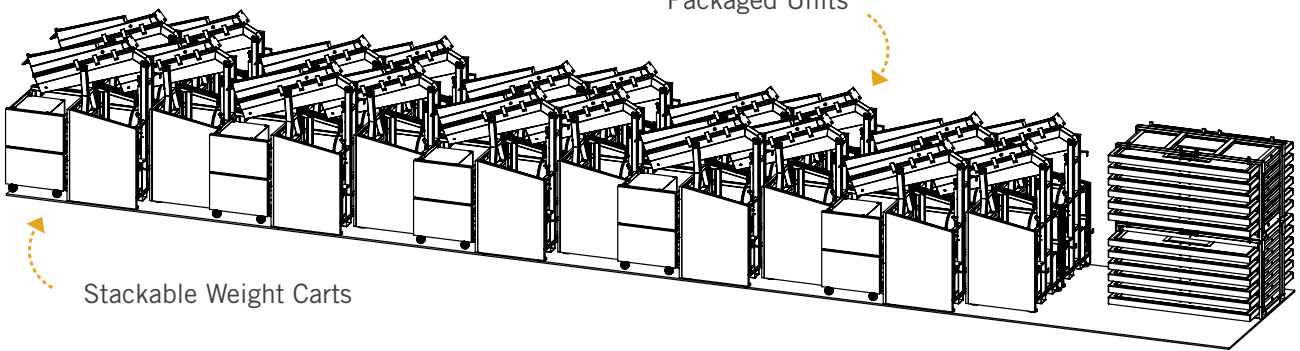



Configuration of units dependent on combination of single and back to back units. Up to 28 units can be shipped on a 53' trailer, subject to backstop configurations and quantity.

BASKETBALL GOALS



1. Steel brace over 50% of the ring circumference for maximum strength
2. Net attachment

<p>Easy Glide™</p>  <p>57" co-polymer cable slides through tubes on bottom perimeter of steel ring</p>	<p>Ram Horn™</p>  <p>Coiled steel configuration for secure and easy attachment</p>
--	---
3. Rims are made of 5/8" cold rolled steel formed to make an 18" inside diameter ring
4. Breakaway or flex mechanism - see below illustration for goal distinction
5. Mounting plate for 5"x5", 5"x4", or universal rims
6. Reflex mechanism available in breakaway or flex goals - located under rim or on top plate
7. Net is included with each goal

GOAL DISTINCTION



POSITIVE LOCK BREAKAWAY GOALS

Spring-loaded to withstand a specific amount of force before breaking away and pivoting downward. Once the force is removed the rim will return to play position.



FLEX BREAKAWAY GOALS

Spring-loaded, so the rim will not breakaway, but instead cause the rim to flex from play position and return once the force is removed.



FIXED GOALS

Made of a hard-wearing steel that will not flex or breakaway but stay strong through repetitive use.

- All Spalding® goals are electrostatically powder-coated orange
- All Breakaway Goals not intended for outdoor use

Easy Glide™
Net System



Official goal
of the NBA

ARENA® 180 GOAL



- Developed for top of the line talent and hard-core dunking
- Meets NBA® dimensional specifications
- 180° positive lock breakaway action
- Safety padded cover plate with foam/rubber upper + lower finger guards
- Anti-whip net + mounting hardware included

413-583 Arena® 180 Goal (5" X 4" Mounting Pattern)

Easy Glide™
Net System



Official goal of the 2020 NCAA®
Men's & Women's Final Four®

SLAM-DUNK® PRECISION 180 GOAL



- Ideal for elite level collegiate play at any angle
- Meets NCAA® & NFHS® dimensional specifications
- 180° Flex breakaway action
- Anti-whip net + mounting hardware included

413-577 Slam-Dunk® Precision 180 Goal
(5" X 5" Mounting Pattern)

413-574 Slam-Dunk® Precision 180sb™ Goal
(5" X 4" Mounting Pattern)

Easy Glide™
Net System



411-705



RAM HORN™ NET
SYSTEM

SLAM-DUNK® GOAL



- Aimed for lower level collegiate play or top high school talent
- Meets NCAA® & NFHS® dimensional specifications
- Flex breakaway action
- For use with 48" and 42" backboards
- Anti-whip net + mounting hardware included

411-704 Slam-Dunk® Goal Easy Glide™ Net
System (Universal Mounting Pattern)

411-705 Slam-Dunk® Goal Ram Horn™ Net
System (Universal Mounting Pattern)

BASKETBALL GOALS

Easy Glide™
Net System

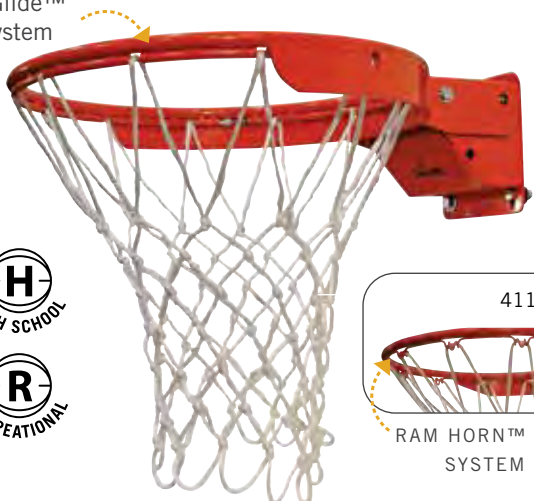

SLAMMER™ COMPETITOR GOAL



- Built for advanced high school or higher-level recreation play
- Meets NCAA® & NFHS® dimensional specifications
- Positive lock breakaway action
- For use with 48" and 42" backboards
- Standard net + mounting hardware included

411-528 Slammer™ Competitor Goal Easy Glide™ Net System (Universal Mounting Pattern)

411-508 Slammer™ Competitor Goal Ram Horn™ Net System (Universal Mounting Pattern)

Easy Glide™
Net System

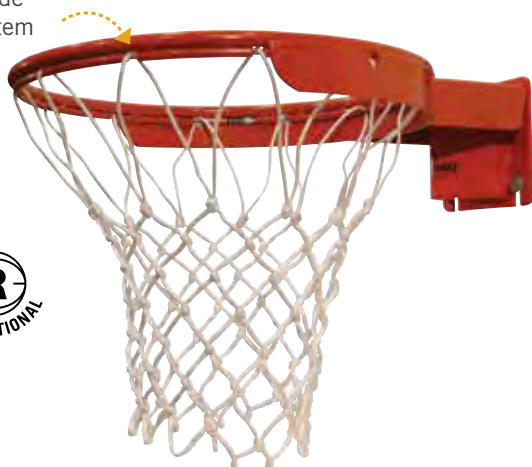

SLAMMER™ COMPETITION 180 GOAL



- Great for light dunking from any direction during recreational play
- Meets NFHS® dimensional specifications
- 180° flex breakaway action
- For use with 48" and 42" backboards
- Anti-whip net + mounting hardware included

411-723 Slammer™ Competition 180° (Universal Mounting Pattern)

Ram Horn™
Net System



SLAMMER™ FLEX GOAL



- Designed for minimal dunking during recreational play
- Flex breakaway action
- For use with 48" and 42" backboards
- Standard net + mounting hardware included

411-506 Slammer™ Flex Goal Ram Horn™ Net System (Universal Mounting Pattern)

RIM DIFFERENTIATION

Positive Lock Breakaway
Flex Breakaway
Fixed

413-583
Arena™
180

413-577
Slam-Dunk™
Precision
180

413-574
Slam-Dunk™
Precision
180sb

411-704
Slam-Dunk™
w/ Easy
Glide

411-705
Slam-Dunk™
w/ Ram
Horn

411-528
Slammer™
Competitor w/
Easy Glide



- All Spalding® goals are electrostatically powder-coated orange
- Fixed goals are recommended for indoor/outdoor use

T-TIE™ Net System



ROUGHNECK™ GORILLA GOAL®



- Fixed goal, with no breakaway action
- For use with 48" and 42" backboards
- Nylon net + mounting hardware included

411-556 Roughneck™ Gorilla Goal®
(Universal Mounting Pattern)

Ram Horn™ Net System

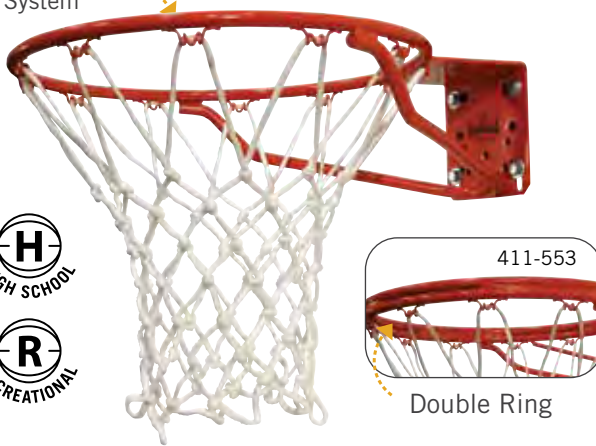

SUPER GOAL™



- Fixed goal, with no breakaway action
- For use with 48" and 42" backboards
- Nylon net + mounting hardware included

411-551 Super Goal™ (Universal Mounting Pattern)
411-553 Super Goal II™ (Universal Mounting Pattern)

Ram Horn™ Net System

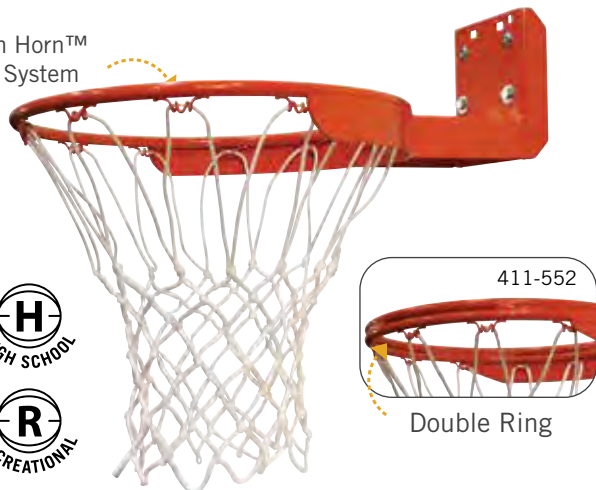

HERCULES®



- Rear variable mount fixed goal, with no breakaway action
- For use with 48" and 42" backboards
- Nylon net + mounting hardware included

411-554 Hercules® (Rear Variable Mounting Pattern)
411-552 Hercules® II (Rear Variable Mounting Pattern)

411-508
Slammer™
Competitor w/
Ram Horn



411-506
Slammer™
Flex



411-723
Slammer™
Competition
180



411-556
Roughneck™
Gorilla



411-551
Super
Goal™



411-553
Super
Goal™ II



411-554
Hercules®



411-552
Hercules®
II



GLASS BACKBOARDS

FEATURES:

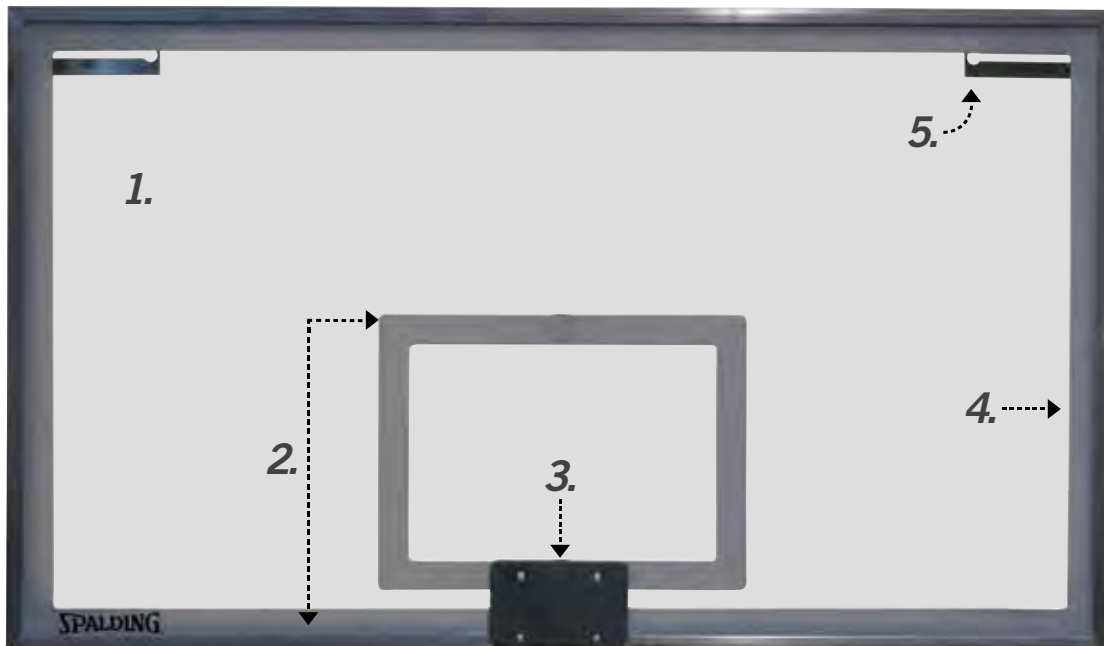

Official backboard of the NBA

1.

1/2" TEMPERED GLASS

2.

2" BORDER AND TARGET ARE FIRED INTO THE GLASS FOR LIFETIME LASTING FINISH

3.

MOUNTING PLATE TO ATTACH TO GOAL
(See board for specific mounting pattern)

4.

5/16" ALUMINUM FRAME FITTED WITH SHOCK ABSORBING MATERIAL TO THE GLASS

5.

FOUR 3/16" THICK KEY HOLE BRACKETS IN THE CORNERS FOR MOUNTING

SUPERGLASS™ PRO BACKBOARD



- Meets FIBA®, NCAA® & NFHS® specifications
- Strongback™ 3" channel for added backboard stiffness
- Direct goal-mount design prevents goal from touching glass
- For use with Wall-Braced & Ceiling-Suspended units
- Includes bottom mounting slots for 4-point options

413-000 Superglass™ Pro Backboard
(72" X 48") (5" X 5" Goal Mounting Pattern)
(42 1/2" X 63" Backboard Mounting Pattern)

413-001 Superglass™ Prosb™ Backboard
(72" X 42") (5" X 4" Goal Mounting Pattern)
(36 1/2" X 63" Backboard Mounting Pattern)

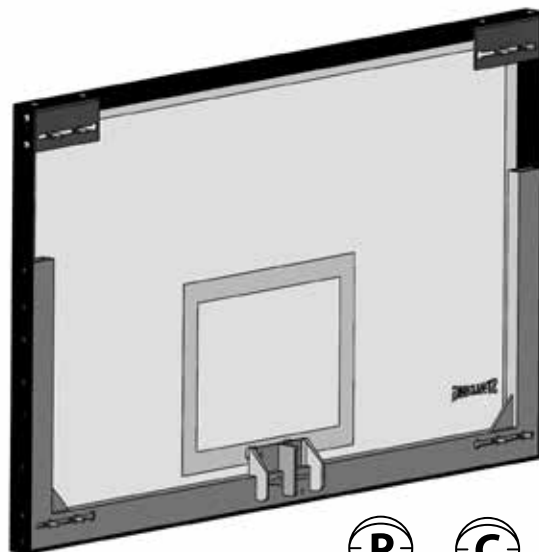

*E-Z Bolt™ padding not included with backboards but recommended.

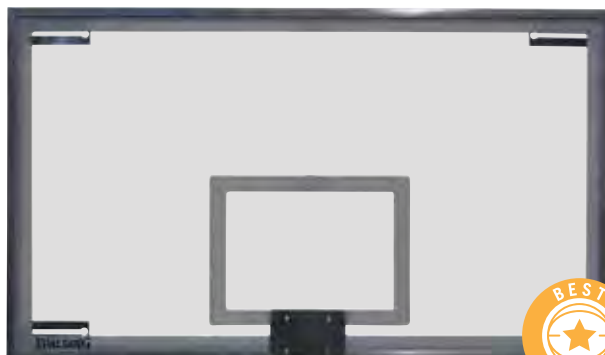

SuperGlass™ CollegiateSB™ Backboard 72" x 42"



SUPERGLASS™ COLLEGIATE BACKBOARD



- Meets NCAA® & NFHS® specifications
- For use with Spalding® Helix® Height Adjuster
- For use with Single Mast Ceiling-Suspended units (mounting bracket purchase may be required)

411-007 Superglass™ Collegiate™ Backboard (72" X 42") (5" X 4" Goal Mounting Pattern) (36" X 63" Backboard Mounting Pattern)

411-008 Superglass™ Collegiate™ Backboard (72" X 48") (5" X 5" Goal Mounting Pattern) (42" X 68" Backboard Mounting Pattern)

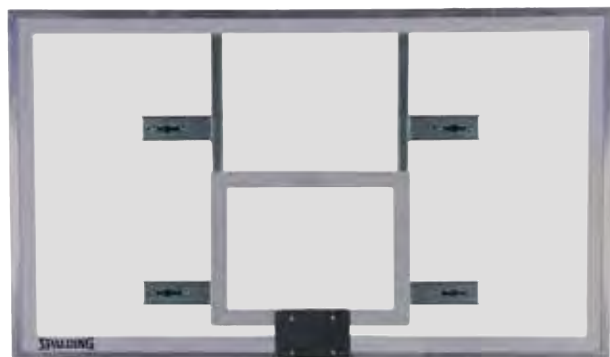

SUPERGLASS™ CONVERSIONSB™ BACKBOARD



- Meets NFHS® specifications
- For use with Spalding® Helix® Height Adjuster
- Built-in Adapter Frame for Fan-Shaped or Rectangular backboards
- For use with Single Mast Ceiling-Suspended units
- Pre-drilled aluminum frame for bolt-on backboard padding

413-019 Superglass™ Conversionsb™ Backboard (72" X 42") (5" X 4" Goal Mounting Pattern) (35" X 20" Backboard Mounting Pattern)



SuperGlass™ Collegiate Backboard with Center Strut 72" x 42"



SUPERGLASS™ COLLEGIATESB™ BACKBOARD WITH CENTER STRUT



- Meets NCAA® & NFHS® specifications
- Four-corner mount design with center strut rim support
- For use with Wall-Braced & Ceiling-Suspended units
- Twenty-year warranty

413-011 Superglass™ Collegiatesb™ Backboard With Center Strut (72" X 42") (5" X 4" Goal Mounting Pattern) (36" X 63" Backboard Mounting Pattern)

EZ BOLT™ PADDING

E-Z BOLT™ PADDING FOR 72" RECTANGULAR BACKBOARDS















- Bolt-on backboard padding for 72" rectangular backboards
- Constructed of molded urethane with 2 ¼" wide channel
- Meets NBA®, NCAA®, FIBA® and NFHS® specifications
- Eight bolts for easy attachment to 72" glass backboards
- Sold as a set that will fit on one 72" glass backboard
- 12 color options available



COLOR OPTIONS



NOTE: Colors shown in catalog and on website may not be an exact match.

- | | | | | | | | | | | | |
|---|---|---|---|---|---|---|---|---|---|---|---|
|  |  |  |  |  |  |  |  |  |  |  |  |
| BLACK
413-421 | GRAY
413-414 | MAROON
413-410 | PURPLE
413-420 | NAVY BLUE
413-419 | ROYAL BLUE
413-418 | LIGHT BLUE
413-417 | FOREST GREEN
413-416 | KELLY GREEN
413-415 | RED
413-411 | ORANGE
413-412 | GOLD
413-413 |

BACKBOARD PACKAGE

1. CHOOSE YOUR BACKBOARD



- **413-000** SuperGlass™ Pro Backboard 72" x 48"
- **413-001** SuperGlass™ ProSB™ Backboard 72" x 42"



- **411-008** SuperGlass™ Collegiate Backboard 72" x 48"
- **411-007** SuperGlass™ CollegiateSB™ Backboard 72" x 42"

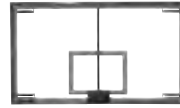

- **413-011** SuperGlass™ CollegiateSB™ with center strut Backboard 72" x 42"



- **413-019** SuperGlass™ ConversionSB™ Backboard 72" x 42"



BACKBOARD PACKAGE DISCOUNT

2. CHOOSE YOUR GOAL



- **411-704** Slam-Dunk® Pro Goal w/ Universal Mounting Pattern
- **411-705** Slam-Dunk® Goal w/ Universal Mounting Pattern



- **411-508** Slammer™ Competitor - Ram Horn™ w/ Universal Mounting Pattern
- **411-528** Slammer™ Competitor Goal - Tube Tie w/ Universal Mounting Pattern



- **413-577** Slam-Dunk® Precision 180 Goal (not compatible w/ 42" boards)
- **413-574** Slam-Dunk® Precision 180SB™ (not compatible w/ 48" boards)



- **411-723** Slammer™ Competition 180 Goal w/ Universal Mounting Pattern

3. CHOOSE YOUR PADDING



- 12 color options available
- Bolt-on backboard padding for 72" rectangular backboards

NOTE: Colors shown in catalog and on website may not be an exact match



BLACK
413-421



GRAY
413-414



MAROON
413-410



PURPLE
413-420



NAVY BLUE
413-419



ROYAL BLUE
413-418



LIGHT BLUE
413-417



FOREST GREEN
413-416



KELLY GREEN
413-415



RED
413-411



ORANGE
413-412



GOLD
413-413

HEIGHT ADJUSTERS



THE HELIX® HEIGHT ADJUSTER HAS SPRING-LOADED TECHNOLOGY WHICH MAKES CHANGING YOUR PLAY HEIGHT A SLAM DUNK!



Check out the Helix Video on our YouTube Channel: [Spalding Helix Height Adjusters](#)

SPALDING® HELIX® FAN HEIGHT ADJUSTER

- For use with 20" x 35" Backboard Mounting Pattern Fan or Conversion Backboards

313-403 Spalding® Helix® Fan Height Adjuster (Each)

313-404 Spalding® Helix® Fan Height Adjuster (Pair)

SPALDING® HELIX® HEIGHT ADJUSTER

- For use with 72" Rectangular Backboards on Single or Double Mast Backstops
- For use with Single or Double Mast units (excluding 413-000 & 413-001)

313-401 Spalding® Helix® Height Adjuster (Each)

313-402 Spalding® Helix® Height Adjuster (Pair)

SHARED FEATURES:



- FOR USE WITH WALL-BRACED AND CEILING-SUSPENDED UNITS
- SPRING-LOADED FOR EASY HEIGHT ADJUSTMENT BETWEEN 8-10 FEET
- HEAVY DUTY PVC-COATED SPRING TO REDUCE NOISE
- INCLUDES CRANK HANDLE WITH HOOK
- NYLON BUSHING FOR SMOOTH MOVEMENT WHILE MAINTAINING SAME RIGIDITY OF NON-ADJUSTABLE SYSTEM
- GRAY POWDER COATED FINISH PROTECTS 1 ½" X 3" STEEL TUBING

NON-GLASS BACKBOARDS



**STEELSB™
BACKBOARD**
72" x 42"



**FIBERGLASSB™
BACKBOARD**
72" x 42"

STEEL BACKBOARD

- Regulation size
- Graffiti-resistant powder coated finish for indoor/outdoor play

413-062 Steel Backboard
(72" X 42") (5" X 4" Goal Mounting Pattern)
(63" X 36" Backboard Mounting Pattern)

FIBERGLASS BACKBOARD

- Regulation size
- 1 1/8" thick, high density thermally-fused panel
- 5-Ply hand-laminated fiberglass for added strength
- Gel Coat finish for moisture resistance

413-051 Fiberglass Backboard
(72" X 42") (5" X 4" Goal Mounting Pattern)
(63" X 36" Backboard Mounting Pattern)



**STEEL FRONT MOUNT
FAN BACKBOARD**
54" x 39"



**FIBERGLASS
FAN BACKBOARD**
54" x 39"

STEEL FRONT MOUNT FAN BACKBOARD

- Reinforced with horizontal channels for vibration-free action
- Vertical Strongback™ for added strength around goal area
- For use with direct mount with gooseneck pole
- Unique bolt-keeper system for easy installation

413-208 Steel Front Mount Fan Backboard
(54" X 39") (5" X 5" Goal Mounting Pattern)
(35" X 20" Backboard Mounting Pattern)

FIBERGLASS FAN BACKBOARD

- For use with direct mount with gooseneck pole

413-230 Fiberglass Fan Backboard
(54" X 39") (5" X 5" Goal Mounting Pattern)
(31 1/2" X 20" Backboard Mounting Pattern)



**Lifetime Warranty On Direct Mount:
1-Year Warranty Otherwise
10 year warranty on Outdoor Products**

ACCESSORIES

BASKETBALL



ANTI-WHIP NET

- Meets NBA specifications

413-625 7 oz. Heavy-Duty Nylon Arena® Anti-Whip Net

- Meets NCAA specifications

413-725 7 oz. Heavy-Duty Nylon 15"-18" Anti-Whip Net



PINK ANTI-WHIP NET

- Cannot be used for competitive play

421-328 7 oz. Heavy-Duty Nylon Pink Anti-Whip



SUPER NET

413-609 9 oz. Heavy-Duty Nylon Super Net



STANDARD NET

413-605 5.6 oz. Standard Nylon Net

GYMNASIUM



ECONOMY SCORER'S TABLE

- Fits seminar tables with 2" thick tops, measuring 72" x 18" and 96" x 18"
- Pads are designed to fit tables 29" high, and come in lengths of 6 or 8 feet
- Mounting brackets can fit up to 2" thick top and are made of formed steel sheet and powder-coated

*Custom logos and school names can be added for an additional fee

COMPLETE TABLE WITH PADS

- **411-224** - 6' Red
411-231 - 8' Red
- **411-225** - 6' Burgundy
411-232 - 8' Burgundy
- **411-226** - 6' Green
411-233 - 8' Green
- **411-227** - 6' Navy
411-234 - 8' Navy
- **411-228** - 6' Royal
411-235 - 8' Royal
- **411-229** - 6' Purple
411-236 - 8' Purple
- **411-230** - 6' Black
411-237 - 8' Black

* 6' & 8' padding can be purchased without table

VOLLEYBALL



GUARD DEFENDER CONFIGURATION

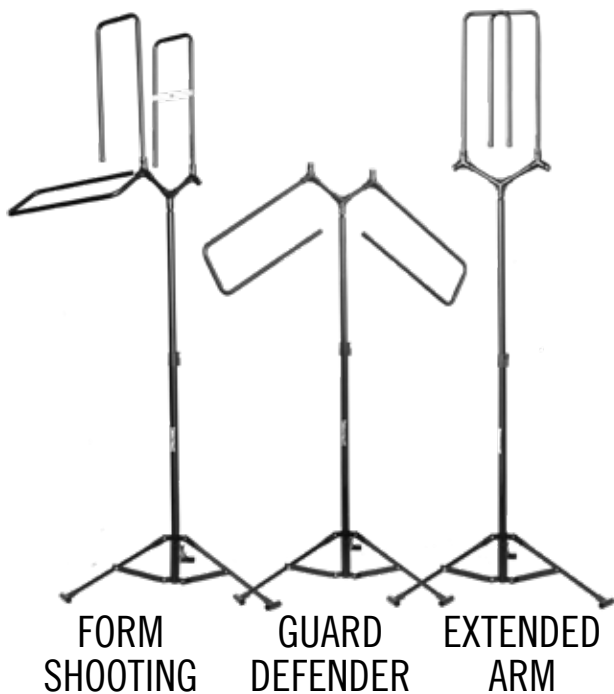

3 IN 1 UNIVERSAL SHOT TRAINER

- Develop the perfect shooting form by keeping your elbow tucked using the form shooting position
- Practice your jumpshots against the extended arm defender
- Work on your cross-overs or step-backs using the guard defender
- Designed for all athletes from 4' to 7' in height

421-560 Universal Shot Trainer

ACCESSORIES

PRACTICE SHOOTING RING

- Trains shooter to be more accurate on their shots
- Intended to improve athletes concentration and confidence when shooting
- Attaches easily to regulation goals reducing target size from 18" to 16"

411-610 Practice Shooting Ring



Rim not included

REBOUND RING

- Develops rebounding skills
- 11" diameter ring installs easily over regulation goal
- Ball can go through ring, but helps teach position and rebounding

411-611 Rebound Ring



Rim not included

MCCALL'S REBOUNDER

- Known as one of the best rebound skill builders on the market
- Sharpens players' rebounding skills
- Ideal tool for increasing grip strength and vertical leap
- Helps improve balance, timing and perception under the goal
- Adjustable from 7' to 12'
- Transports easily on built-in smooth rolling casters
- Not meant for women's play

411-621 McCall's Rebounder



SPORT TABLE

- 24"L x 24"W x 24"H
- 24" Diameter acrylic table top
- Steel post and rim with net set on top of a wood base platform

421-355 Sport Table



ADD MORE ARC TO YOUR SHOTS!



Balls not included

NBA® BALL TRUCK

- Holds 18 full size basketballs
- Constructed of steel tubing with grey powder-coat finish
- Includes swivel wheels
- Non-topple base
- Angled rails for easy ball removal

411-603 NBA® Ball Truck

REPLICA BALL TRUCK

- Holds 15 full size basketballs
- Constructed of durable chrome steel tubing
- Swivel casters
- Non-topple base
- Angled rails for easy ball removal

411-602 Replica Ball Truck



Balls not included

ECONOMY BALL TRUCK

- Constructed of chrome steel tubing
- Swivel casters
- Non-topple base
- Holds up to 12 balls

411-600 Economy Ball Truck



Balls not included

BALL LOCKER

- Constructed of welded steel
- Non-marring swivel casters
- Lockable
- Holds up to 30 basketballs or 36 volleyballs

411-605 Ball Locker



CEILING-SUSPENDED

FEATURES:

1. STEEL BEAM CLAMP

2. LYNRUS AUTO-LOC SAFETY STRAP

3. 3 1/2" O.D. SUPPORT PIPE

4. 1/4" AIRCRAFT CABLE

5. STEEL SADDLE CLAMP

6. ADJUSTABLE LEVEL HINGE HANGER

7. LYNRUS QR4000 HP KEY-OP WINCH

8. 4" TOP CHANNEL

9. SAFETY CABLES AT EACH COMPONENT ATTACHMENT

10. 2" x 14 GAUGE SQUARE TUBING SWAY BRACE

11. 6 5/8" O.D. x 10 GAUGE MAST

12. POWDER-COAT IN SPALDING® BLUE VEIN

13. UPPER BANK EXTENSION

14. 42" x 72" GLASS BACKBOARD

15. BREAKAWAY GOAL WITH DIRECT ATTACHMENT

16. E-Z BOLT™ BACKBOARD PADDING

CEILING-SUSPENDED BACKSTOP



- Vertical main mast consists of 6 5/8" O.D. x 10 gauge pipe sized tubing with 2" x 14 gauge square tubing sway braces to construct a solid frame work
- Our 4" top channel helps support the adjustable backstop hinge hangers which allow precise frame placement, leveling and alignment during installation
- Meets official NCAA® and NFHS® Specifications
- Framework is adaptable to any configuration of Spalding® backboard
- Laboratory tested safety cables are placed at every connection point to help protect against personal injury and/or property damage
- Spalding® blue vein powder-coat finish (custom colors available)

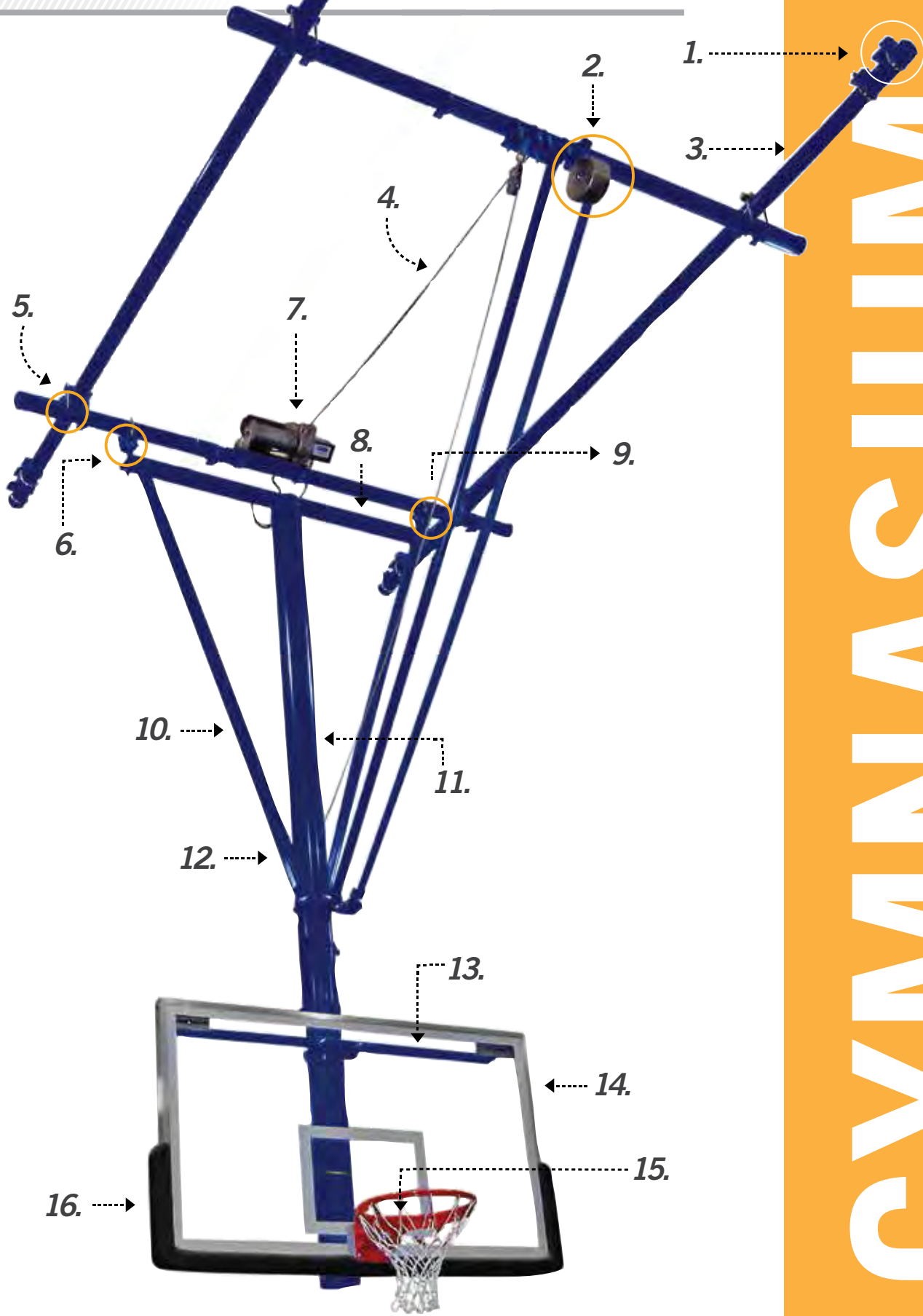

GYMNASIUM



SAFETY

At Spalding, your gym's safety is our top priority!

We engineer all Spalding® ceiling-suspended units with high quality hardware, customizable powder coated parts, safety cables, and even include back-up systems like the Auto-O-Loc 2 safety strap on all Spalding® mechanized ceiling-suspended backstops.

Our gym construction and renovation team will work with your facility crew to assess your needs, specify the right equipment and provide a quality and safe installation. It doesn't matter if you are working on a new gym or are making updates to your existing wall or ceiling-suspended systems, divider curtains, wall padding, volleyball equipment or other gym equipment, Spalding can help. Our certified installers are available and offer full-service work to complete your project.

For all your gymnasium needs, contact Spalding at
800-435-3865 | INQUIRE@SPALDINGEQUIPMENT.COM.

You can also find all certified Spalding GymPro dealers on our website at
WWW.SPALDINGEQUIPMENT.COM.

CEILING MAST



GLIDING REAR-BRACED CEILING MAST

- Smooth operation forward-fold unit
- Offers our maximum retraction height, most stable from 16' to 34' attachment height
- Includes all bracing hardware on rear of mast for cleaner game play
- Can be installed as retractable or stationary unit



ALL-PURPOSE CEILING MAST

- Offers front, back, and side folding options with minimal ceiling connection footprint
- Self-locking braces store in same direction as unit folds for cleaner look

CONTACT US AT 1-800-435-3865 FOR CUSTOM COLOR OPTIONS

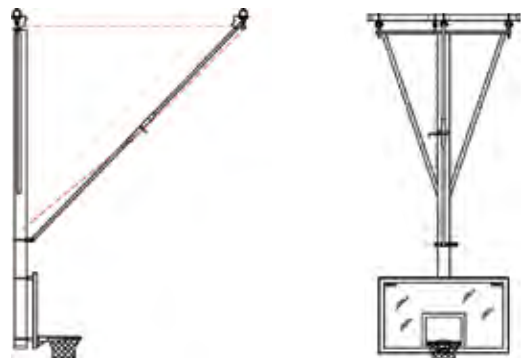

WALL-BRACED



WALL-BRACED STATIONARY

- Available in lengths from 8" to 13' from wall
- Framework made of four 2" square, steel tube cross-braces and extension tubes
- Tube ends include ¼" heavy duty flange for attaching to 2"x6" wallboards and backboard



WALL-BRACED SIDE FOLD

- Available in lengths from 3' to 13' from wall
- Telescoping diagonal brace includes locking mechanism and adjustable collar, allowing unit placement as desired in playing area (from the floor, utilizing included hand crank)
- Framework made of four 2" square, steel tube cross-braces and extension tubes
- Tube ends include ¼" heavy duty flange for attaching to 2"x6" wallboards and backboard



WALL-BRACED FOLD-UP BACKSTOP

- Available in lengths from 3' to 13' from wall
- Framework made of four 2" square, steel tube cross-braces and saddle welded braces
- Tube ends include ¼" heavy duty flange for attaching to 2"x8" wallboards and backboard
- Backstop raised by 1,000lb manual winch using ¼" steel cable running through 3 ½" diameter deep groove cable pulley on the upper wallboard



SHARED FEATURES:



- COMPATIBLE WITH ALL BACKBOARDS AND HEIGHT ADJUSTERS
- ¼" STEEL CABLES INCLUDED TO SUPPORT STRUCTURE

- CUSTOM COLORS AVAILABLE
- * PLEASE SEE PRICE LIST FOR PART NUMBERS

BATTING CAGE



← ↑
CAGE EASILY RAISES AND
LOWERS FROM THE CEILING
↓ →



BATTING CAGE

- Designed for indoor use only
- Frame is constructed of zinc-coated piping
- Minimum ceiling height requirement of 17'
- Cast fittings connect perimeter
- 1 hp electric motor
- Netting attaches easily to the frame with hook and loop straps
- Black net is made of a high strength polyethylene material
- Standard mesh size is 1 3/4" with 3/4" mesh available for golf

-
- 417-278 Motorized Retractable 70' Cage (net not included)
 - 417-279 Motorized Retractable 55' Cage (net not included)
 - 417-386 14' wide x 70' long Batting Cage Net Package
 - 417-387 12' wide x 70' long Batting Cage Net Package
 - 417-388 14' wide x 55' long Batting Cage Net Package
 - 417-389 12' wide x 55' long Batting Cage Net Package
 - 417-395 14' wide x 70' long Golf Mesh Cage Net Package

DIVIDER CURTAINS

SHARED FEATURES:

CURTAINS HAVE 1" OUTER EDGES THAT ARE DOUBLED TO ELIMINATE FRAYING

LOWER SECTION OF THE CURTAIN IS CONSTRUCTED OF A SOLID 18 OZ. VINYL AND THE UPPER SECTION MADE OF A 9 OZ. MESH WITH 2" WELDED SEAMS.

THIS PRODUCT MEETS THE CALIFORNIA STATE FIRE CODE

ONE-YEAR LIMITED WARRANTY ON MATERIALS AND WORKMANSHIP



CUSTOM CURTAINS OPTIONS AVAILABLE - CONTACT US AT 1-800-435-3865 FOR DETAILS

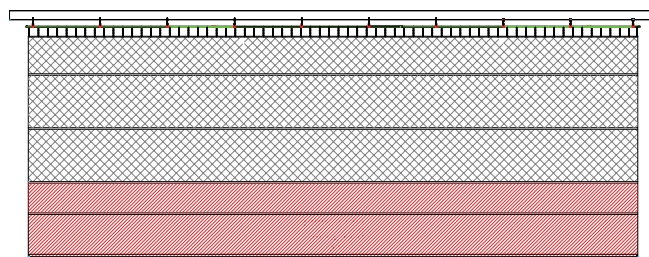

WALK-DRAW

- The most cost effective way to divide your gym.
- Best curtain option for maximum clearance on ceiling heights below 28'.
- A 3" pocket lines the bottom edge of the curtain to accommodate the coil-proof chain as a weighted base.
- Track is made from 16 gauge galvanized steel which holds trolley wheels for easy mobility .
- Vinyl fabric lines the top edge of the curtain with grommets every 12", which attach to the carriers and s-hooks.
- Storage space is $\frac{1}{8}$ " per foot of the curtain.
- Curtain does not utilize a winch, but is moveable by manpower similar to a shower curtain.

AVAILABLE VINYL COLORS



RED



BURGUNDY



ORANGE



GREEN



MARINE
BLUE



PURPLE



ROYAL
BLUE



NAVY



TAN



GRAY



BLACK

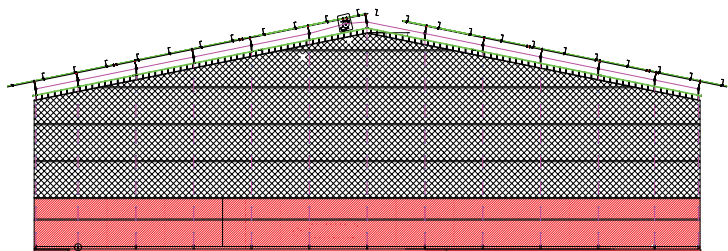
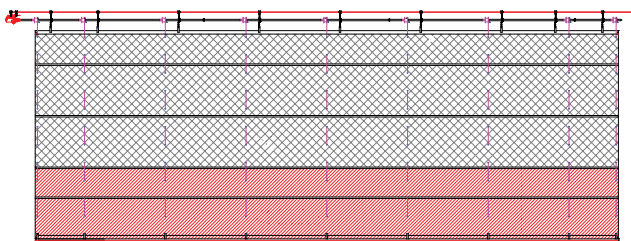

FOLD UP

- Offers a clean way to divide your gymnasium into two useful areas.
- Accordion folds are powered by $\frac{1}{8}$ " steel cables running through grommets vertically, to a clean pocket at the bottom of the curtain with a weighted pipe.
- Cables wrap neatly on a 5" spool rotated by a $\frac{3}{4}$ hp electric winch.
- Strap connection to bottom batten tube to prevent sharp edges.

RIDGE FOLD

- These custom curtains contour to the slope of your facility's roof line for maximum ceiling coverage.
- When raising the curtain, it accordion folds by $\frac{1}{8}$ " steel cables running through grommets vertically which pass through overhead pulleys drive by a $\frac{3}{4}$ hp electric winch.
- Vinyl fabric lines the top edge of the curtain with grommets every 12", that attach to the carrier and s-hooks.
- S-hooks attach on the top of the curtain by a chain and carrier rollers that sit in a 16 gauge steel channel track keeping nice lines.

AVAILABLE MESH COLORS



BLACK



GRAY



BLUE



GREEN



YELLOW



WHITE



RED

ALL COLORS ARE CAL 117, NFPA 701, ASTM E84, COMPLIANT
NOTE: COLORS SHOWN IN CATALOG AND ON WEBSITE MAY NOT BE AN EXACT MATCH

DIGITAL GRAPHIC WALL PADS



INSTALLATION TIP:

Wall pads should be a minimum of 6' high and installed at a maximum of 6" above the finished floor

All digital graphics are printed using state-of-the-art, six-color large format printers. Durable, vivid inks are designed to be long-lasting relative to the silk-screens and vinyl applications of the past. High resolution printing provides sharp image quality from any distance.

- Any of our wall pads can be custom printed to match your logo and color scheme specifications
- Full color printing allows unlimited color options
- Artwork is printed directly onto vinyl covers and attached to backing material

Please contact Spalding® at 1-800-435-3865 for ordering information and specifications on custom digital graphics.

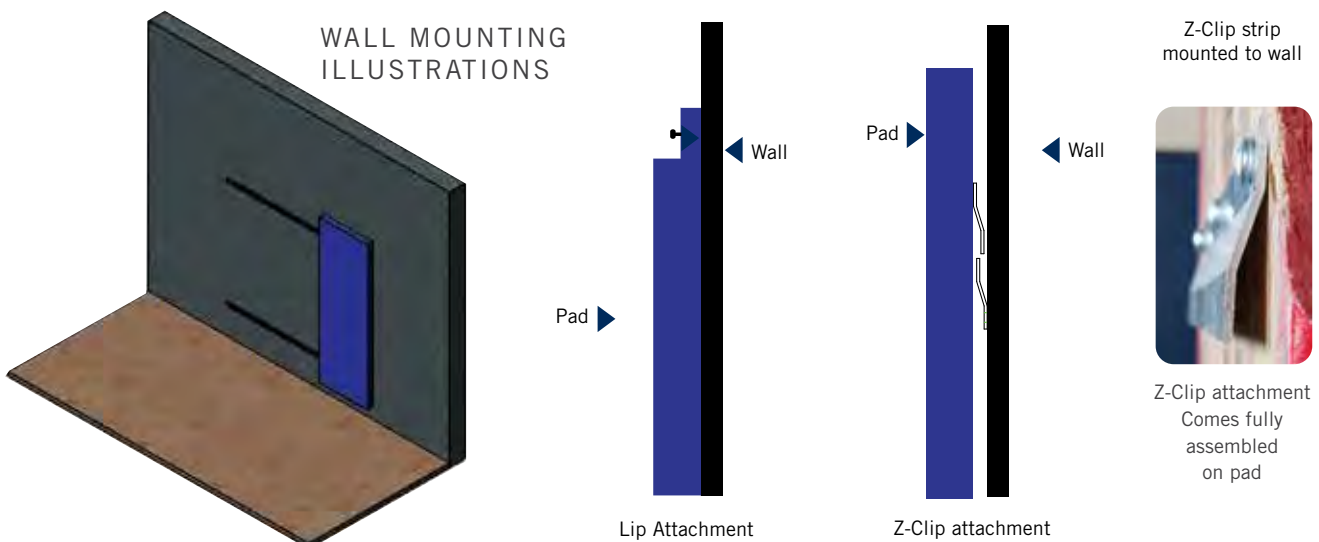

WALL PADDING

BASKETBALL

GYMNASIUM

VOLLEYBALL

SHARED FEATURES:

- STANDARD WALL PAD SIZE IS 2' X 6'
- CHOOSE FROM A VARIETY OF STANDARD COLORS

- PAD MEETS NATIONAL FIRE PROTECTION STANDARD 701, ASTM E-84 AND CAL 117
- 2 ⁷/₁₆" (62MM) THICK PROTECTIVE WALL PADDING CAN BE INSTALLED PERMANENTLY OR REMOVABLE



- O.S.B. Backing
- Polychloroprene foam
- Vinyl cover

CLASS A FIRE WALL PADS

- Constructed of ⁷/₁₆" (11mm) O.S.B. backing, 2" polychloroprene foam and 18 oz. vinyl cover
- Class A Fire Rating (meets ASTM E84 testing procedures)



- O.S.B. Backing
- 100 ILD Polyurethane foam
- Vinyl cover

2" POLYURETHANE WALL PADS

- Constructed of ⁷/₁₆" (11mm) O.S.B. backing, 2" 100 ILD polyurethane foam and 18 oz. vinyl cover



- O.S.B. Backing
- Laminated Polyurethane foam
- Vinyl cover

2" LAMINATE WALL PADS

- Constructed of ⁷/₁₆" (11mm) O.S.B. backing, 2" laminated polyethylene foam and 18 oz. vinyl cover



FOR ORDERING INFORMATION, CONTACT 1-800-435-3865
SPALDING® EQUIPMENT 2020 | 43

COMPONENTS

AUT-O-LOC SAFETY BELT

- Designed specifically for today's moving and folding backstops.
- Lightweight - only 14 lbs. / 6.43kg.
- Rated for a maximum of 1,000 lbs. / 453.51kg.
- Fully automatic.
- Spring loaded to retract up to 35 feet. Optional 45 foot / 13.7 meter lead belt is also available.
- Inertia plate activates three separate pawls to minimize shock and instantly stop the load before it gains momentum.



402-865 Aut-O-Loc Safety Belt for Backstops
401-875 Retractor Reel (not shown)

CURTAIN LOCK

- The Curtain Lock is designed to stop a shaft from rotating in the event of a sudden unexpected increase in speed or a gradual over-speed.
- Load Rating: 1250 lbs. of suspended load on a 2 3/8" pipe diameter (max loads will vary by diameter of cable spool).
- Speed Rating: Unit will lock at approximately 200 RPM or 1 foot per second on a 2 3/8" drum.
- The unit only locks in one direction. Arrow on hub of the Curtain Lock indicates the downward rotation of device and should be tested prior to powering your equipment.



402-225 Curtain Lock
017330 Curtain/RBC Winch

Q4 ELECTRIC WINCH

- 115 volt, single phase, instantly reversing 3/4 HP motor.
- Over 1,250 lbs. of vertical line pull at 9 feet per minute.
- Large grooved drum with a 4 1/2" diameter.
- High speed worm gear supported for both radial and thrust loads.
- Positive locking - double reduction worm gear drive provides a 200:1 reduction rate.
- Sealed gear case provides a lifetime of maintenance-free operation.
- Includes Deluxe Key Switch.



402-742 QR4000 Electric Winch
301-064 Winch Retrofit/Refurb Kit (not shown)

REMOTE CONTROL TRANSMITTER FOR ELECTRIC WINCH



- Program up to 99 devices within your gym
- Works in conjunction with 301-088

301-087 Remote Control Transmitter for Electric Winch



MANUAL WINCH 1,000 LB. CAPACITY WITH CRANK HANDLE



- Heavy-duty 1,000 lb. capacity
- Efficient 40:1 worm gear ratio
- Long-lasting, ball-bearing type thrust bearing
- Maintenance-free lifetime sealed gear case

402-760 Manual Winch 1,000 lb. Capacity with Crank Handle
014-815 Replacement Handle

DELUXE KEY SWITCH FOR ELECTRIC WINCH



- Works in conjunction with 301-088

402-980 Deluxe Key Switch for Electric Winch



REMOTE CONTROL RECEIVER FOR ELECTRIC WINCH



- Works in conjunction with 301-087

301-088 Remote Control Receiver for Electric Winch



