

THE PERFECT LOCK

SIMPLE | SUSTAINABLE | SECURITY



Simple

- Easy keyless operation
- Pick-your-own combination and locker
- Manager access retains user code
- Convenient reset from front
- Perfect for assigned or shared, wet or dry areas



Sustainable

- Green: No batteries or harmful waste
- Solid metal design for long term use
- No weak plastic components or wires
- No operating expenses or maintenance
- 5 year warranty



Secure

- Reprograms to alternate master keys
- 10,000 possible combinations
- Break-away-knob for maximum security
- No weak plastic components or wires
- Anti-pick



MODEL: KEYLESS1-SN

KEYLESS¹ combination lock for lockers

WORLDWIDE REFERENCES:

- | | | | |
|----------------------|--------------------|----------------|---|
| • Gold's Gym | • Nike | • Texas A&M | • Dallas Cowboys Stadium |
| • 1Rebel | • Intel | • Four Seasons | • 24 Hour Fitness |
| • Rolls Royce | • Google | • David Barton | • Northwestern Mutual |
| • Boeing | • Brick Bodies | • TD Bank | • Chicago Athletic Clubs |
| • Delta Airlines | • Equinox | • Shell | • Executive Health Clubs |
| • Merck | • Soul Cycle | • BP | • New York Athletic Club |
| • GoodLife Fitness | • Amazon | • Porsche | • Cerro Verde (Venezuela) |
| • Planet Fitness | • Fitness Time | • Visa | • The Olympic Athletic Club – San Francisco |
| • Wellbridge Clubs | • Hyatt | • Empire State | • Campestre de |
| • MVP Athletic Clubs | • Lifetime Fitness | • Pepsi Co. | Chihuahua (Mexico) |
| • ACAC Clubs | • Fitness First | • Ritz Carlton | |

KEYLESS.CO

1875 W. Walnut Hill Lane
Irving, TX 75038, USA



✉ info@keyless.Co
☎ +1 972.331.2770
🌐 www.keyless.Co



Instructions

KEYLESS1 User Instructions

TO LOCK

1. Close the door
2. Make sure knob is pointing up to , then set any 4 digit code
3. Turn knob to 
4. Scramble the code

 See how it works: www.keyless.Co/instructional-videos

TO UNLOCK

1. Re-enter your code
2. Turn the knob up to 
3. Open the door
4. Scramble the code for the next user



KEYLESS1 Manager Instructions





Insert the Code Retrieval Key and turn the knob to 



With each dial: spin until it stops; center middle digit in window. After setting each dial, the last used code will display





Turn the knob back to  and remove the key. Then return the knob to  and scramble the code for the next user.

 See how it works: www.keyless.Co/instructional-videos

KEYLESS1 Card Lock User Instructions

TO LOCK

1. On the back of the door, insert membership card at the red arrow
2. Close the door
3. Make sure arrow is pointing up to , then set any four digit code
4. Lock door by turning knob to 
5. Scramble the code

 See how it works: www.keyless.Co/instructional-videos

TO UNLOCK

1. Re-enter your code
2. Turn the knob up to 
3. Open the door
4. Scramble the code for the next user
5. Remove your membership card

Architectural Specifications

LOCK ROUTING

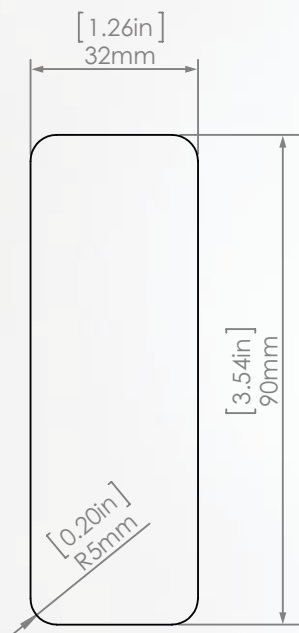

FRONT VIEW

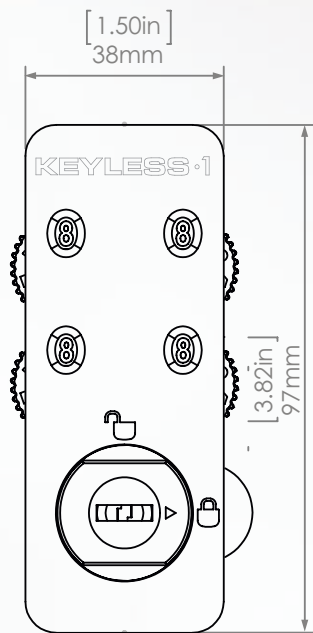

TOP VIEW

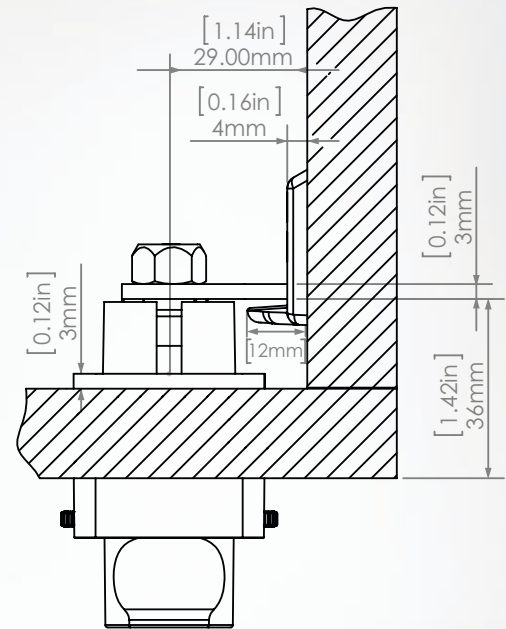

FEATURES:

- Sustainable - no batteries, no wires, no waste
- Reprogrammable to alternate master keys. Simply insert new manager key to rekey.
- Easy keyless operation
- Locks with any user selected 4 digit code
- 10,000 possible combinations
- Break-away-knob for maximum security
- Assigned or shared use
- Manager access retains user code
- Resets from front
- Solid metal design for long term heavy use/no plastic components
- Satin nickel finish

- For indoor use in wet or dry areas
- Integrated knob/pull
- Recess mounted
- Accommodates doors 1-32mm/0.04"-1.26" thick
- Standard cam offset 25mm/1"
- Converts easily from other lock types
- 5 year warranty

OPTIONAL ACCESSORIES

- Strike plate with 12mm/0.47" catch
- ADA lever – meets ADA requirements
- Cam with offset 32mm/1.26", 39mm/1.54"
- Card Actuator

2010 ADA Standards



KEYLESS1-ADA

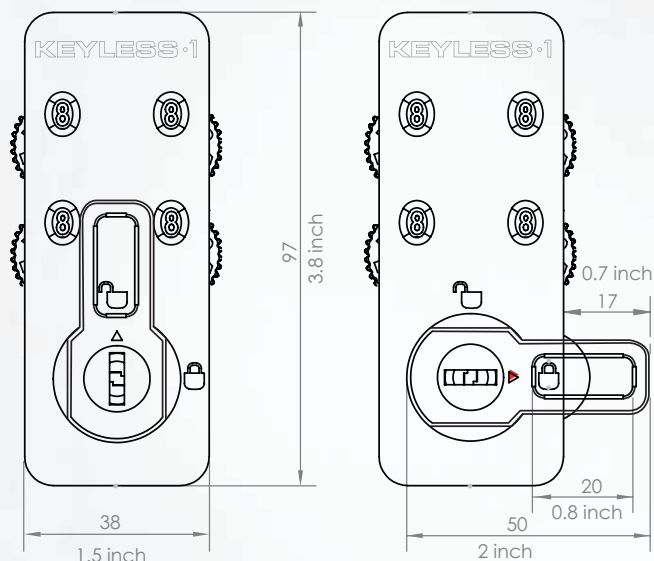

2010 ADA Standards for Accessible Design requirements:

1. 5% of lockers and their operable parts, the locks, must meet ADA specifications
2. Locks shall be operable with one hand
3. Shall not require tight grasping, pinching, or twisting of the wrist to operate
4. Shall have a force required to activate of 5lbs (22.2N) maximum
5. Locks shall be installed maximum 48"/ 1220mm from the floor surface

KEYLESS1-ADA FEATURES:

- Meets the 2010 ADA Standards for Accessible Design
- Allows flexibility to use locker as ADA or standard
- Reprograms to new manager key by using next key in sequence
- Easy keyless operation
- Satin nickel finish
- Solid metal design for long term heavy use
- Green: no batteries or harmful waste
- Locks with any user selected 4 digit code
- 10,000 possible combinations
- Manager access retains user code
- Resets from front
- Break-away-knob for maximum security
- Integrated lever serving as a pull
- Recess mounted, compatible with wood, phenolic, glass and some metal lockers
- Accommodates doors 1-30mm/0.04"-1.18" thick
- Standard cam offset 25mm/1", other offsets available
- Strike plate with 12mm/0.47" catch
- Assigned or shared use
- For wet or dry areas
- 5 year warranty

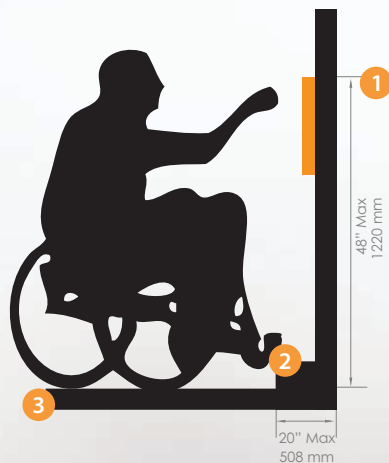

- 1 Highest touch point
- 2 Front Edge of block
- 3 Top of finished floor



See how it works:
[www.keyless.Co/
 instructional-videos](http://www.keyless.Co/instructional-videos)



Specifications

ARCHITECTURAL SPECIFICATIONS, SECTION 10 51 61 BUILT-IN SUSTAINABLE COMBINATION CAM LOCKS FOR LOCKERS

PART 1 - GENERAL

1.1 SUMMARY

Built-in, combination locks can be factory installed by the wood, glass, plastic, metal locker manufacturer or field installed on either existing or new wood lockers. Field installed locks can be part of a complete construction project or can be purchased directly by the owner and installed by the building maintenance staff.

A. Section includes:

1. Built-in, sustainable combination locks to be [factory installed on lockers.] [field installed on existing lockers.] [field installed on lockers specified in other sections.]

B. Related sections:

1. [Section 10 51 13 - Metal Lockers] [Section 10 51 16 - Wood Lockers] [Section 10 51 26 - Plastic Lockers] [Section 10 51 43 - Wire Mesh Storage Lockers]: Lockers to receive built-in combination locks.

1.2 SUBMITTALS

A. Provide in accordance with Section 01 33 00 - Submittal Procedures:

1. Product data for locks.
2. Installation instructions.
3. User and manager instructions.

PART 2 – PRODUCTS

2.1 ACCEPTABLE MANUFACTURERS

A. Keyless.Co, LLC

1875 W Walnut Hill Lane, Suite 140
Irving, TX 75038, USA
Phone: 972.331.2770
info@keyless.co, www.keyless.co.

B. Substitutions: Not Permitted.

C. Requests to use equivalent products of other manufacturers shall be submitted in accordance with Section 01 63 00 – Product Substitution Procedures.

2.2 SUSTAINABLE COMBINATION CAM LOCKS

A. Type: Model **KEYLESS1** or Model **KEYLESS1-ADA** in Satin Nickel finish as manufactured by **Keyless.Co, LLC**

1. Built-in, high security, sustainable (not battery operated) combination cam lock with solid metal housing and durable metal dials with textured lip for non-slip and integrated knob serving as a pull.

2. With reprogrammable cylinder to a new master key.

3. Resistant to humidity.

4. With unique master key override without disturbing the user's selected code. User's forgotten code must be conveniently reset from front of the lock.

5. Locks/Unlocks with any user selected 4-digit code. Up to 10,000 possible combinations.

6. Not battery operated, not generating ongoing maintenance cost.

7. Durable, with no weak plastic components.

8. Mandatory 5 year replacement warranty.

9. Not requiring any management tools or software.

10. Keyless1-ADA model with ADA compliant lever requires force of less than 5Lbs and no pinching, or twisting of wrist to operate.

11. For shared or assigned use environments.

B. Mounting: Concealed in locker door 1mm-32mm/0.04" - 1.26" thick on wood, plastic, glass or metal lockers.

C. Operation: one-handed, grip-and-pull operation. Locks/unlocks with any user selected 4 digit code. Operated by 90 degree right-hand turn of the knob or lever. Not battery operated to prevent generating ongoing maintenance cost. Must not require power and locker or combination management system or license to operate.

PART 3 – EXECUTION

3.1 INSTALLATION

A. Locks shall be installed in accordance with lock manufacturer's instructions.

Include the following paragraph if locks are to be factory installed on lockers prior to delivery to site.

B. Factory install built-in combination locks on lockers as part of [Section 10 51 13 – Metal Lockers] [Section 10 51 16 - Wood Lockers] [Section 10 51 26 - Plastic Lockers] [Section 10 51 43 - Wire Mesh Storage Lockers] [Section [] - []].

Include the following paragraph if locks are to be field installed in either existing or new lockers.

A. Field install built-in combination locks in [existing lockers.] [new lockers specified in [Section 10 51 16 - Wood Lockers] [Section 10 51 26 - Plastic Lockers] [Section [] - []].

B. After installation operate each lock to ensure proper operation. Correct deficiencies and adjust for smooth operation

C. Demonstrate to Owner's representative:

1. Use of lock combinations and supervisory access with master key.